

APPLICATION

Temperature resistant detonator for oilfield use. Top fire application.

ELECTRICAL PARAMETERS

Resistance: $50 \pm 2\Omega$
 No fire current: 0.2 A / 5 minutes
 All fire current: 0.8 A / 1 second

ELECTROSTATIC SENSITIVITY

7 KV / 2000 PF
 25 KV / 500 PF / 5 KΩ
 (Valid for pin-to-pin, pin-to-case, shorted-pins-to-case)

EXPLOSIVES

Primary charge: 80mg PbN₆ 1.23 grains
 Base charge: 525mg HNS 8.10 grains

TECHNICAL INFORMATION

- Remove shunt wire before arming
- Requires booster for reliable end to end ballistic transfer
- Use tubular nut (included) to position/fix booster in gun top sub
- Do not re-use gun top sub in excess of 10 times

SHELF LIFE

5 years at storage condition: -40°C to +60°C, -40°F to +140°F; maximum 65% relative humidity, good ventilation.

DISPOSAL

Detonators should be destroyed only by authorized persons and in accordance with all applicable laws, regulations and company procedures.

SPECIFICATIONS

Part No.	Classification	CE Number	UN Number	D.O.T.
2323358	1.4S	0080.EXP.11.0015	0456	EX2013040601

TEMPERATURE RESISTANCE

Temperature in °C	Temperature in °F
260°C / 1hr	500°F / 1hr

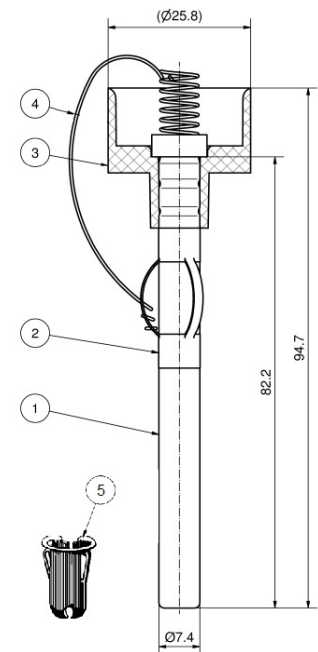

All Dimensions in mm

1. Detonator
2. Grounding Spring
3. Rubber Sleeve
4. Shunt
5. Tubular Nut

PACKING INFORMATION

Quantity per box	50 pcs
Gross weight per box	13.70 kg
Net weight per box	1.00 kg
NEC per box	0.03 kg
Dimensions of box	33cm x 32cm x 23cm
Product Weight	20 g
Package Type	Steel Case + Vacuum Bag
+/- 5 % tolerance in weights	